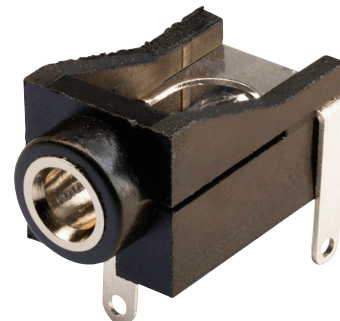

**MODEL:** MJ-3536NG | **DESCRIPTION:** AUDIO JACK

**FEATURES**

- isolated ground
- internal tip switch

**SPECIFICATIONS**

parameter	conditions/description	min	typ	max	units
rated input voltage			12		Vdc
rated input current				1	A
contact resistance				30	mΩ
insulation resistance	at 500 Vdc	100			MΩ
voltage withstand	for 1 minute			500	Vac
insertion/withdrawal force		0.3		3	kg
operating temperature		-40		85	°C
storage temperature		-10		50	°C
life			5,000		cycles
RoHS	yes				

**SOLDERABILITY**

parameter	conditions/description	min	typ	max	units
wave soldering	dipped in solder pot for 10 seconds max		260	265	°C

## MECHANICAL DRAWING

units: mm  
 tolerance:  
 X.X ±0.30 mm  
 X.XX ±0.20 mm  
 X.XXX ±0.10 mm  
 PCB: ±0.05 mm  
 unless otherwise specified

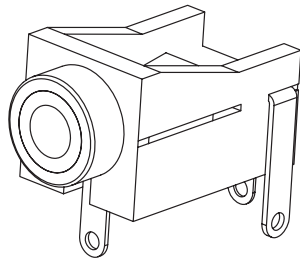

DESCRIPTION	MATERIAL	PLATING/COLOR
terminal 1	brass t=0.30	copper-tin
terminal 2	phosphor bronze t=0.20	copper-tin
terminal 3	brass t=0.40	copper-tin
housing	PA66 (UL94HB)	black

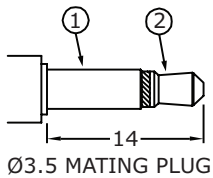
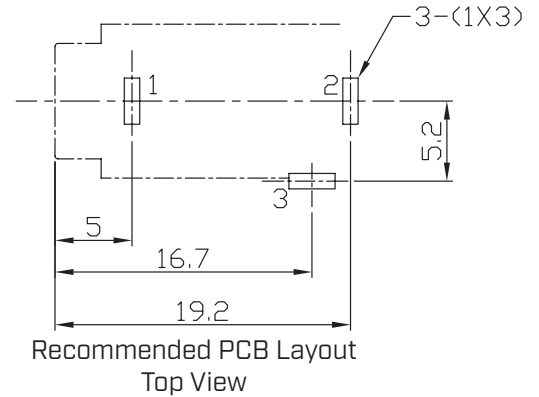
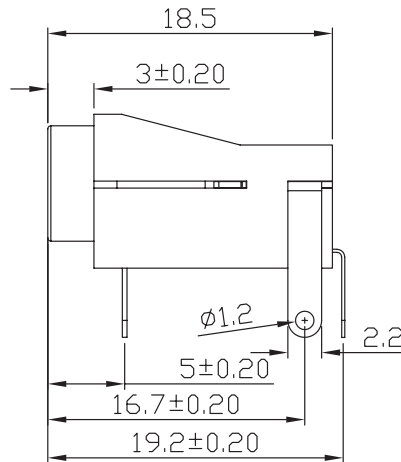
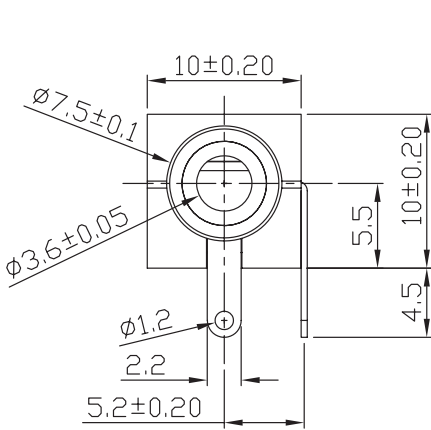
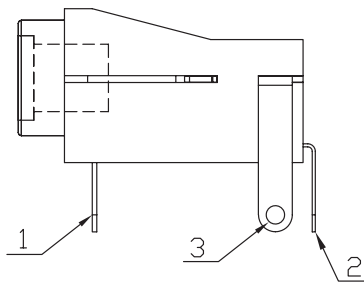
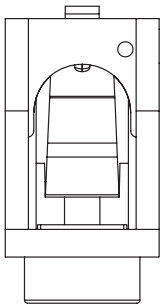

Model No.	MJ-3536NG
Schematic	
PIN	
1	sleeve
2	tip
3	tip switch

## REVISION HISTORY

rev.	description	date
1.0	initial release	11/11/2005
1.01	added PCB slot dimensions	10/07/2010
1.02	brand update	02/03/2020
1.03	product reengineered for improved manufacturability and production yield, see PCN for details	02/22/2023

The revision history provided is for informational purposes only and is believed to be accurate.



CUI Devices offers a one (1) year limited warranty. Complete warranty information is listed on our website.

CUI Devices reserves the right to make changes to the product at any time without notice. Information provided by CUI Devices is believed to be accurate and reliable. However, no responsibility is assumed by CUI Devices for its use, nor for any infringements of patents or other rights of third parties which may result from its use.

CUI Devices products are not authorized or warranted for use as critical components in equipment that requires an extremely high level of reliability. A critical component is any component of a life support device or system whose failure to perform can be reasonably expected to cause the failure of the life support device or system, or to affect its safety or effectiveness.

[cuidevices.com](http://cuidevices.com)